

FIRE PROTECTION: WINDOWS

RATING: -/90/90

SYSTEM: Forster Fuego Light Insulated Steel Framing System



Incorporating the Forster Fuego Light insulated Steel Framing system combined with Pilkington Pyrostop® fire rated glass, these windows achieve a rating of -/90/90 FRL to AS1530.4

Highly suited for applications that require windows to provide protection against the spread of flames and full protection of heat transfer for up to 90 minutes, whilst retaining the safety and aesthetics of a fully transparent window. Especially suitable for fire escape corridors, fire walls, and protection of essential services equipment.

FEATURES

- Fixed windows up to 2900 x 1400 for each lite (larger sizes possible on request)
- Fire resistance to -/90/90
- TPS - Forster Fuego Light 110 x 50 steel insulated framing system
- Single and multi-panel applications - unlimited continuous length
- Suitable for internal or external application
- Available in powdercoat or paint finish
- Easily integrated with TPS -/60/30 glazed fire doors
- Excellent U-values
- Very high sound reduction
- Grade A impact rated to AS2208
- Curved heads, angles, circles available
- Triple glazing available for improved energy/shading performance
- System also available as -/120/120, -/60/60, -/60/30 FRL (contact TPS for more information)
- Suitable for integration with TPS -/60/30 glazed sliding door system (contact TPS for more information)
- Full DWG drawings and architectural support available (please contact TPS for assistance)
- Continuous curtain walls possible using Forster Thermfix Vario fire rated curtain wall system
- Full glass data available from technicalprotection.com.au





TECHNICAL DATA

Glass	Thickness	FRL	Application	Max glass pane dim (mm)	Max glass pane area (m2)	Light transmission	U _g (W/m2K)	SHGC	R _w (C;Ctr) dB	Weight (Kg/m2)
Pilkington Pyrostop® PS90-200	47mm	-/90/90	Internal or external	2830	3.7	75%	2.7	0.61	42 (-1; -4)	96

HOW TO SPECIFY

Glazing to be fully certified TPS -/90/90 window incorporating 47mm (for internal or external applications) Pilkington Pyrostop® multi-laminate fire resistant intumescent glazing with Forster Fuego Light fully insulated steel framing system, available via Technical Protection Systems approved distribution network.

Contact Technical Protection Systems Pty Ltd for further information:

W technicalprotection.com.au **P** 03 9720 1930 **E** info@technicalprotection.com.au

TYPICAL SECTIONS

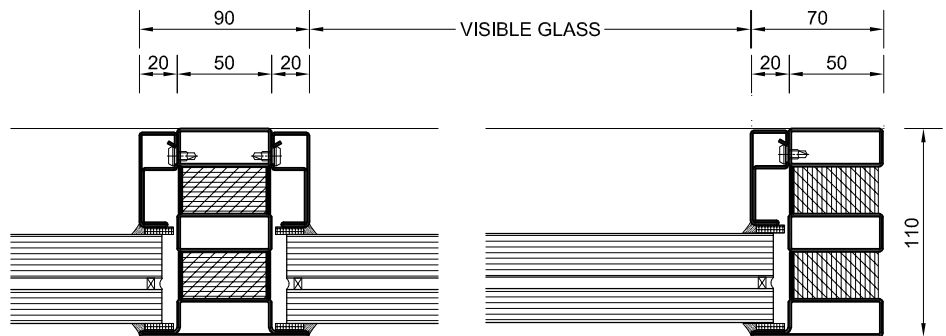
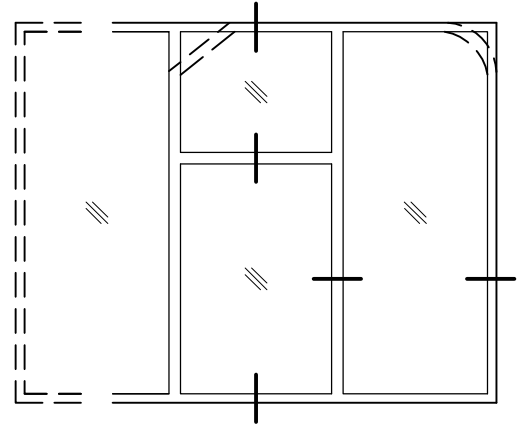
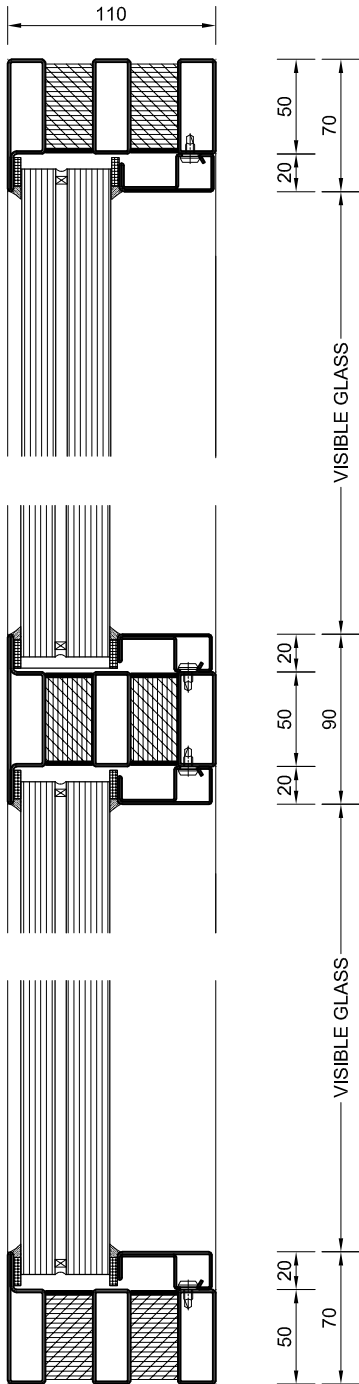

TYPICAL VERTICAL SECTION

TYPICAL HORIZONTAL SECTION

TYPICAL GLAZING OPTIONS

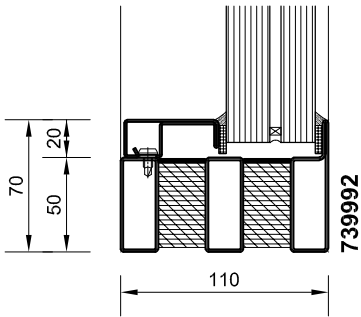

47mm GLASS, WET SEAL
SINGLE GLAZING BEAD
INTERNAL / EXTERNAL USE

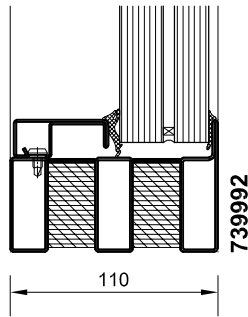

47mm GLASS, DRY SEAL
SINGLE GLAZING BEAD
INTERNAL USE ONLY

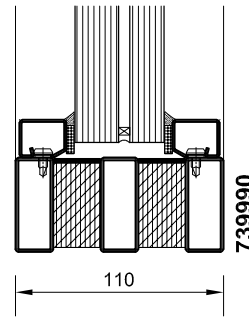

47mm GLASS, WET SEAL
DOUBLE GLAZING BEAD
INTERNAL USE ONLY

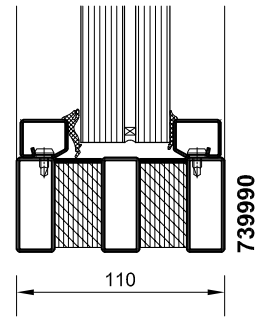

47mm GLASS, DRY SEAL
DOUBLE GLAZING BEAD
INTERNAL USE ONLY

TYPICAL WALL ABUTMENTS

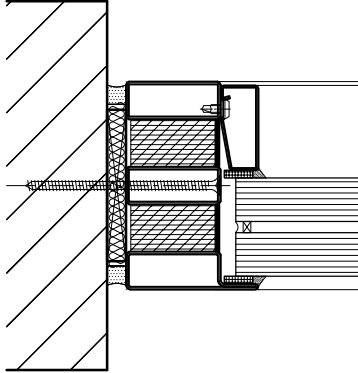

MASONRY WALL

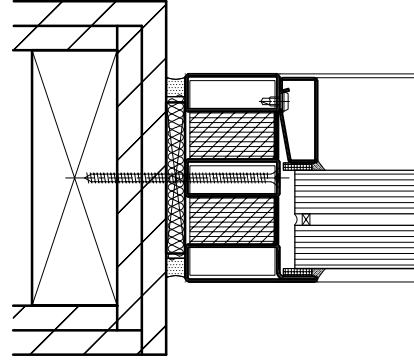

LIGHTWEIGHT FRAME WALL

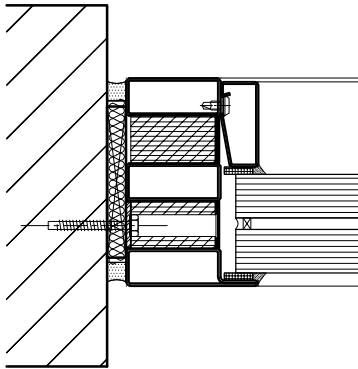

MASONRY WALL

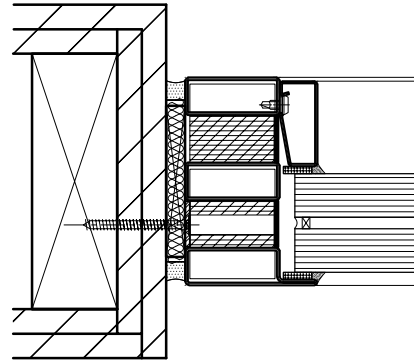

LIGHTWEIGHT FRAME WALL

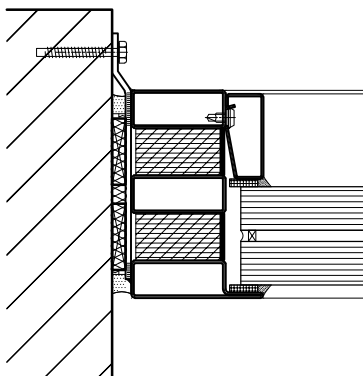

MASONRY WALL

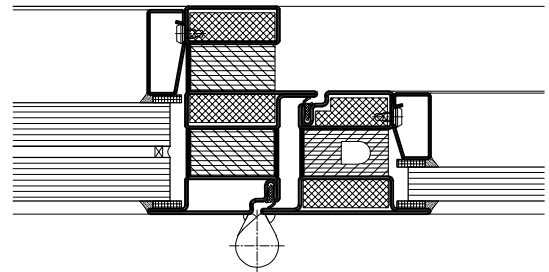

FUEGO LIGHT HINGED DOOR